

House	Storehouse 44C	Sheet	1
-------	----------------	-------	---

Drawing	3D	Scale	
---------	----	-------	--

Material	44X135	Date	06.04.2017
----------	--------	------	------------

Drawer	RP	File	Storehouse 44C 3D.dwg
--------	----	------	-----------------------

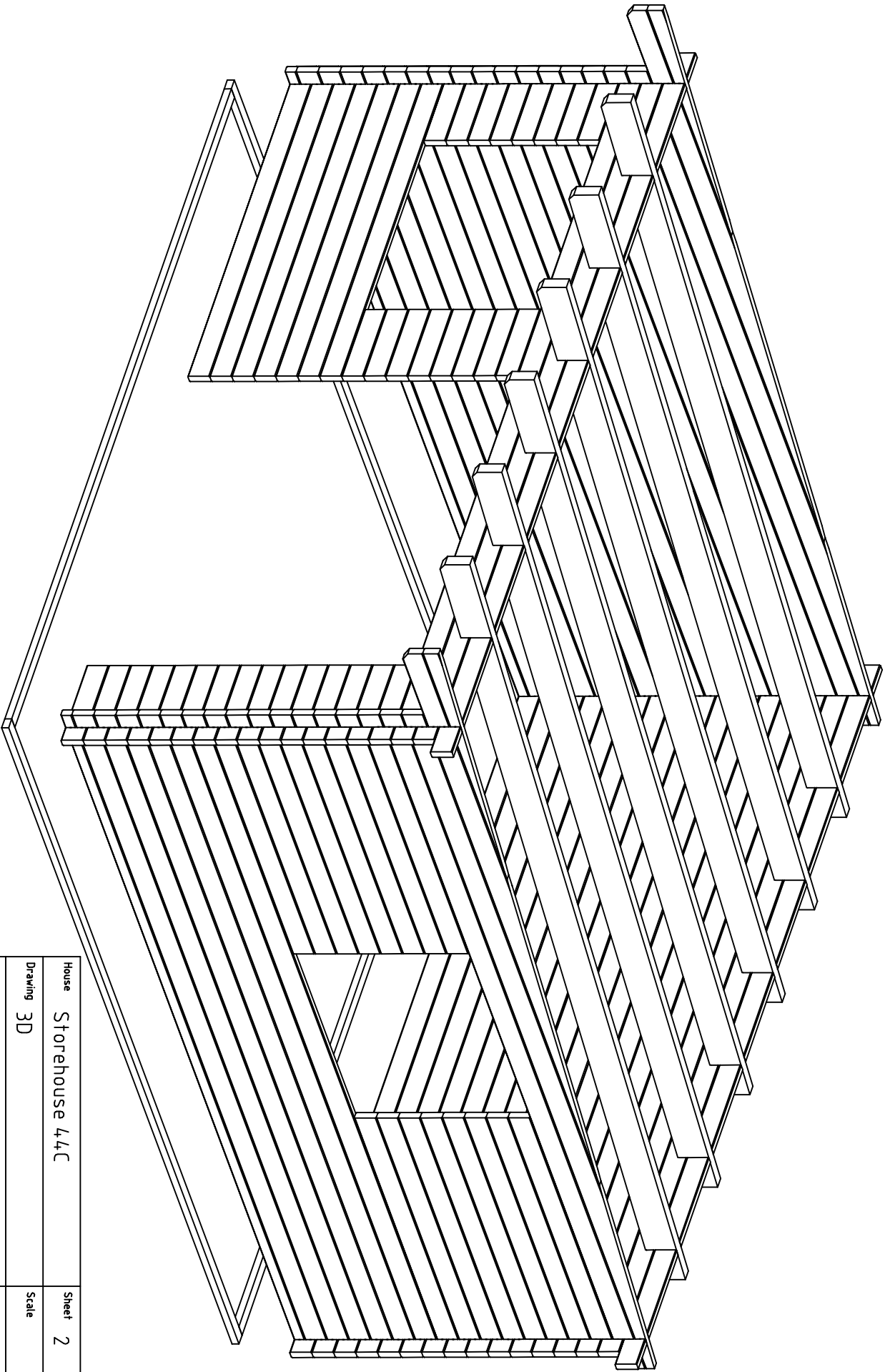

House	Storehouse 44C	Sheet	2
Drawing	3D	Scale	
Material	44X135	Date	06.04.2017
Drawer	RP	File	Storehouse 44C 3D.dwg

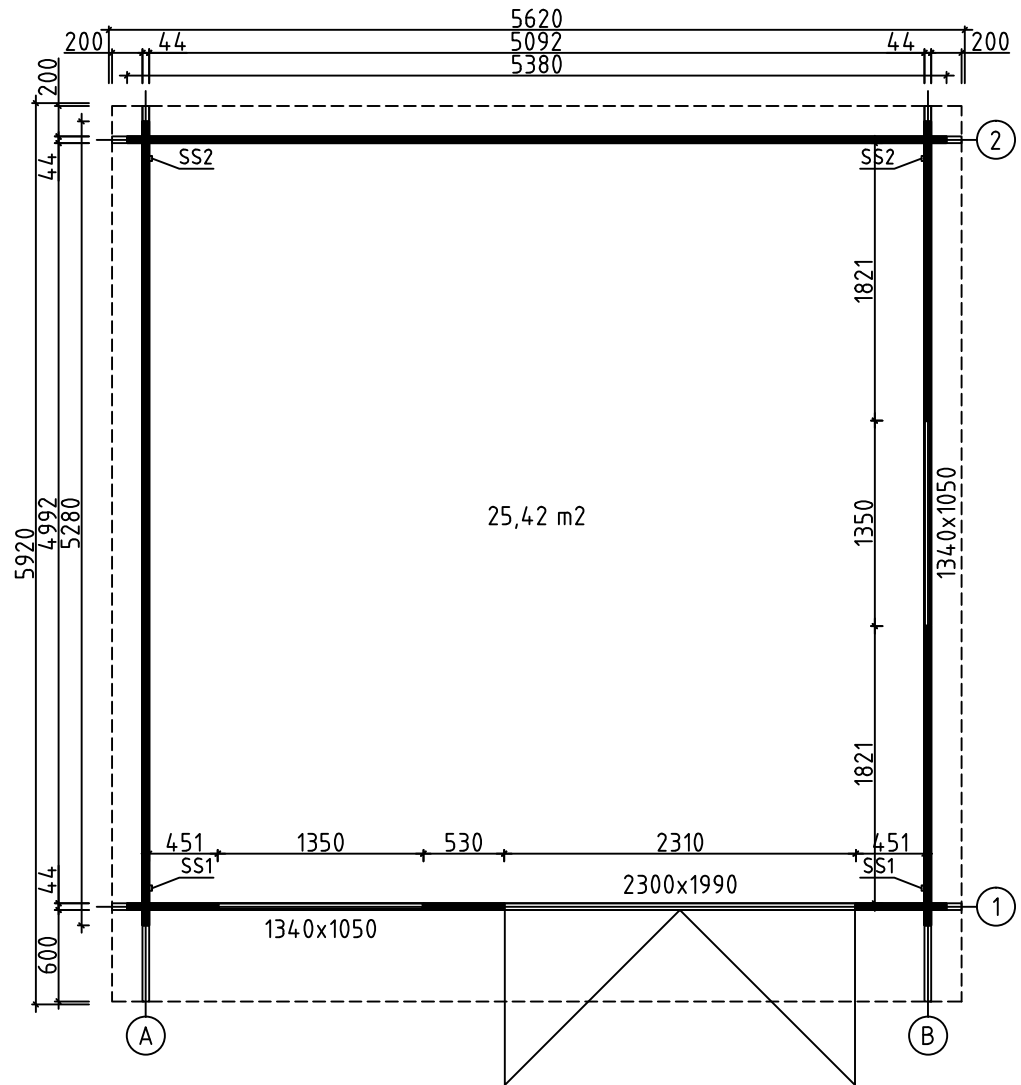

House	Storehouse 44C	Sheet	3
Drawing	GRUNDPLAN-GRUNDPLAN-PLAN	Scale	1:50
Material	44x135	Date	06.04.2017
Drawer	RP	File	Storehouse 44C.dwg

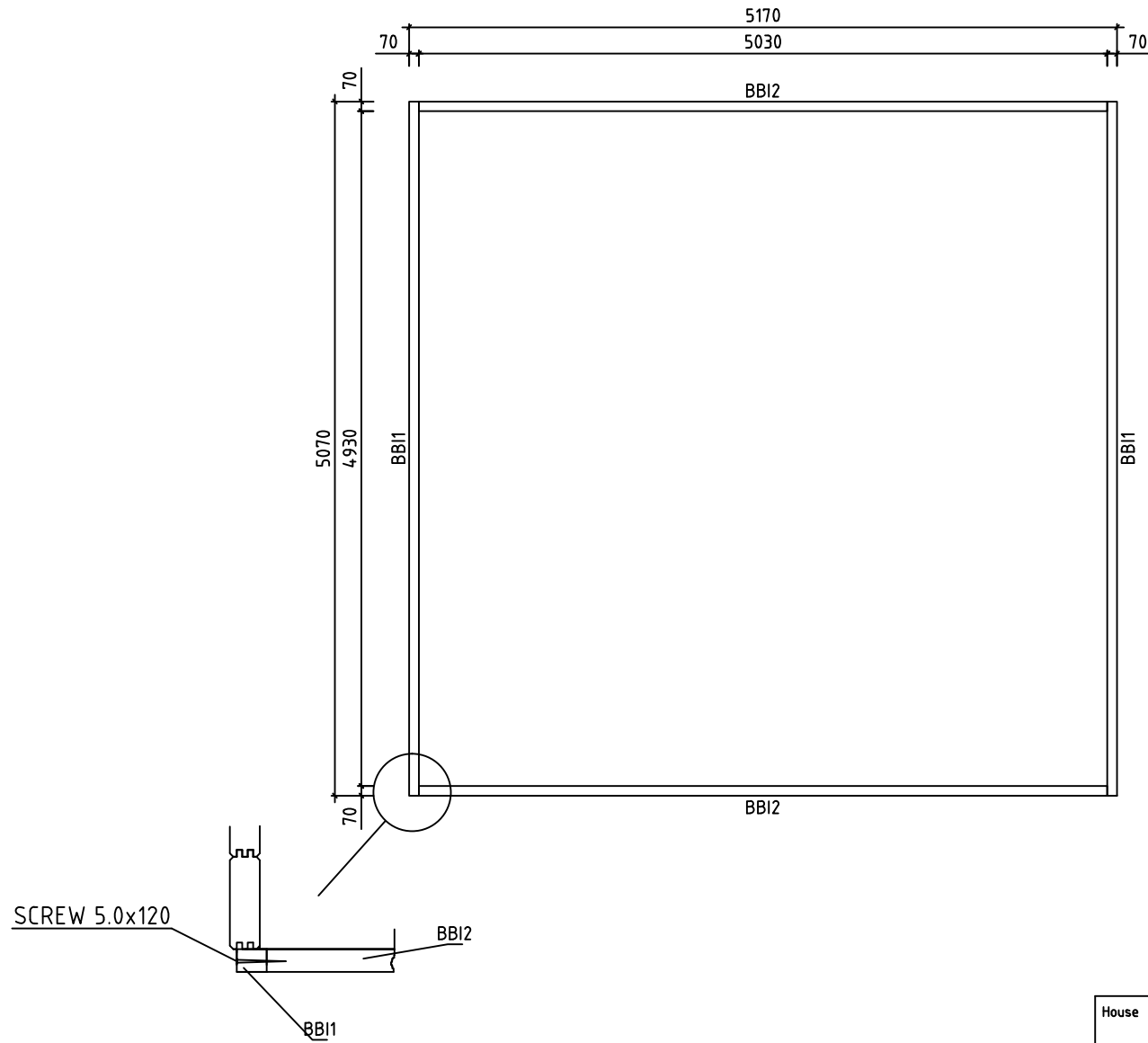

House	Storehouse 44C	Sheet	4
Drawing	BASE BEAMS-LAGERHÖLZER-ONDERBALKEN	Scale	1:50
Material	70x43	Date	06.04.2017
Drawer	RP	File	Storehouse 44C.dwg

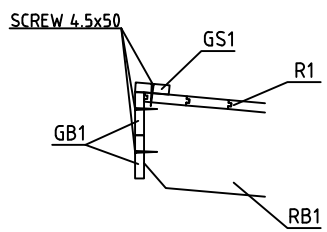
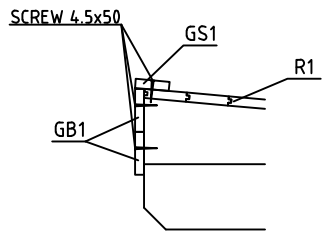

Wall-Wand-Muur A ↗

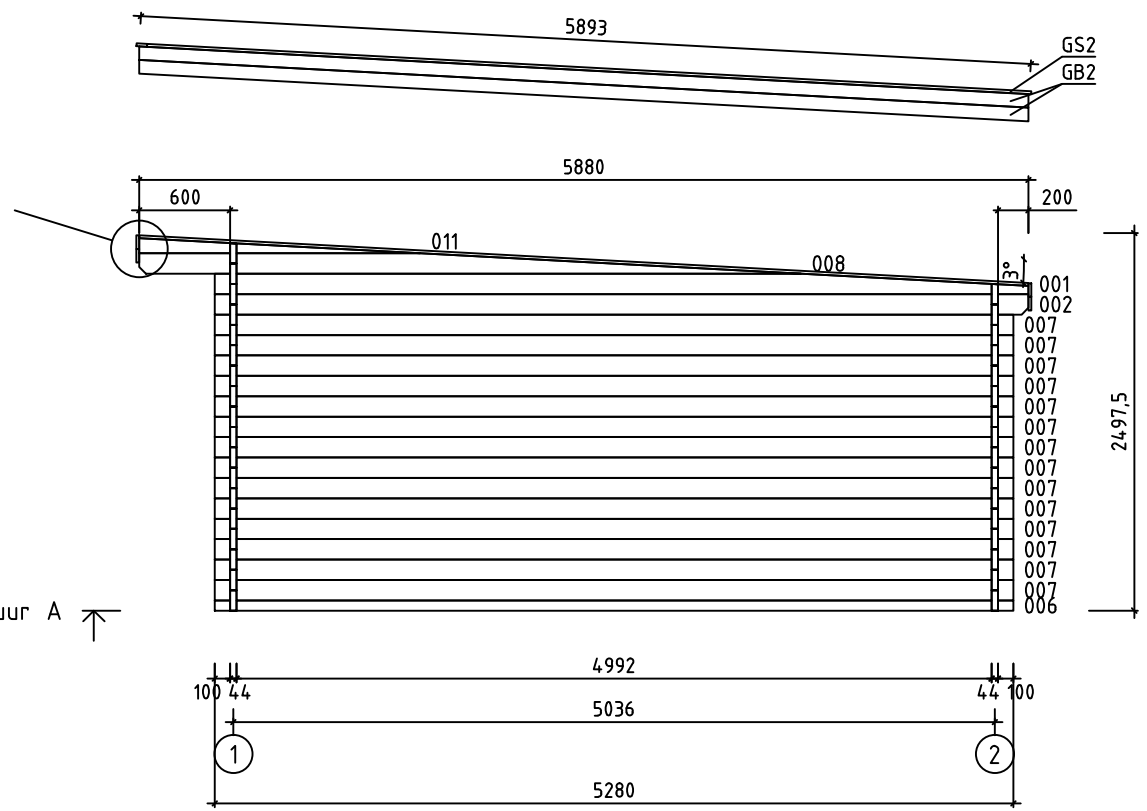

House	Storehouse 44C	Sheet	5
Drawing	WALL-WAND-MUUR A	Scale	1:50
Material	44x135	Date	06.04.2017
Drawer	RP	File	Storehouse 44C.dwg

Wall-Wand-Muur B ↗

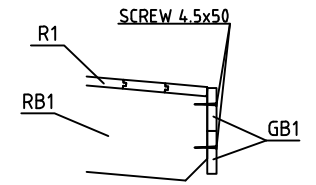
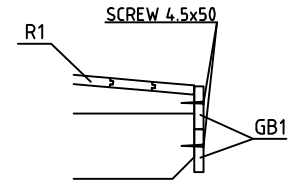
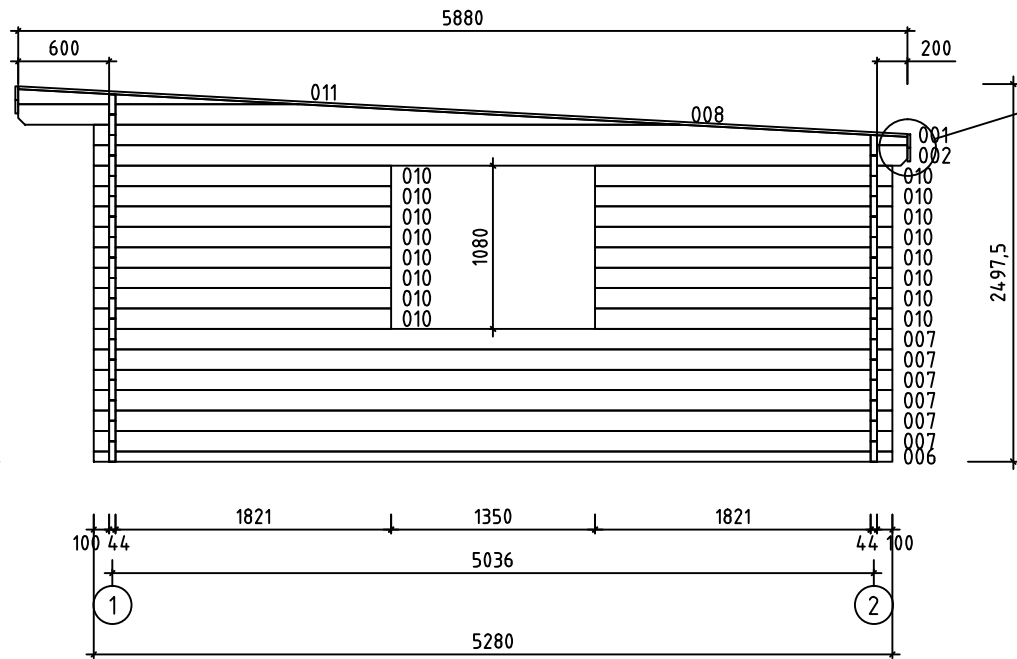

House	Storehouse 44C	Sheet	6
Drawing	WALL-WAND-MUUR B	Scale	1:50
Material	44x135	Date	06.04.2017
Drawer	RP	File	Storehouse 44C.dwg

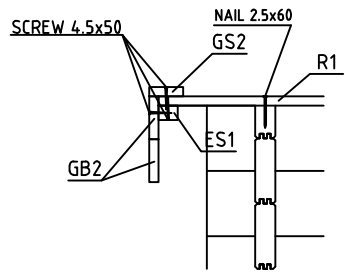
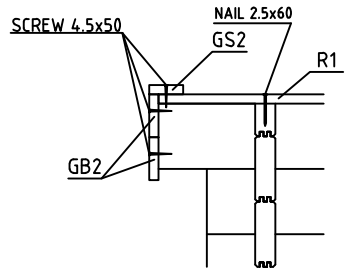

Wall-Wand-Muur 1 ↗

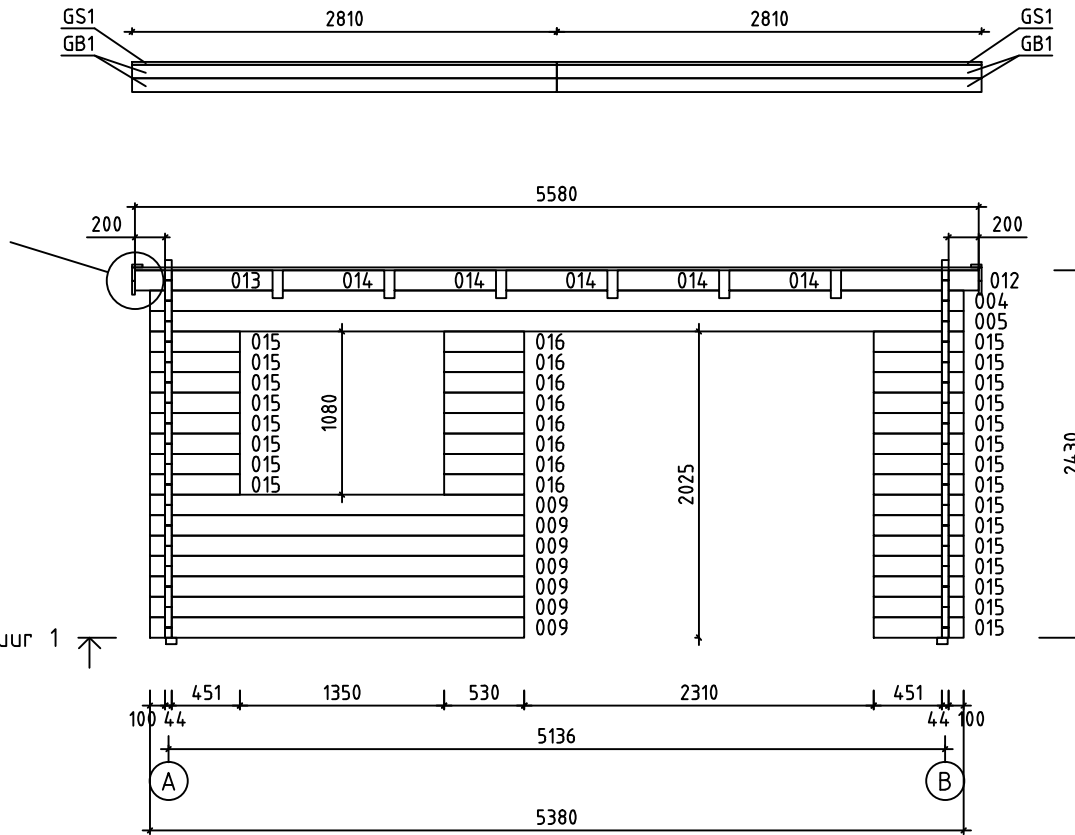

House	Storehouse 44C	Sheet	7
Drawing	WALL-WAND-MUUR 1	Scale	1:50
Material	44x135	Date	06.04.2017
Drawer	RP	File	Storehouse 44C.dwg

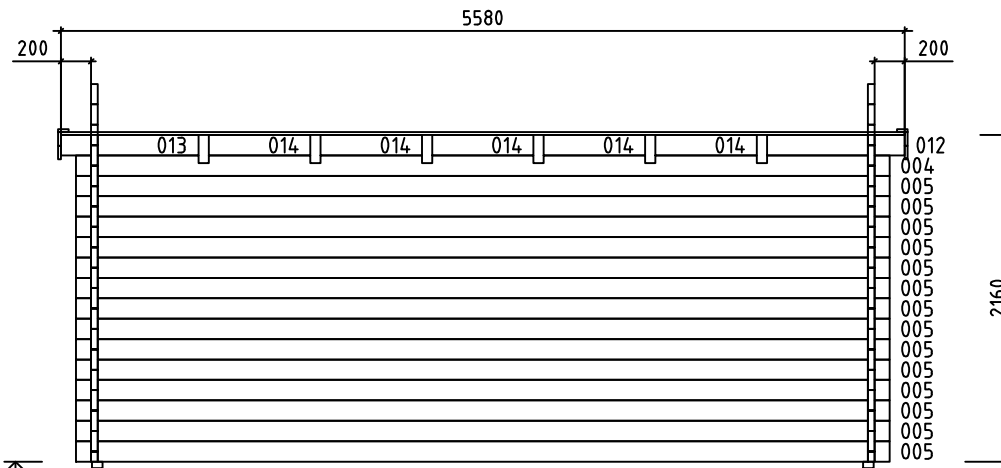

Wall-Wand-Muur 2 ↗

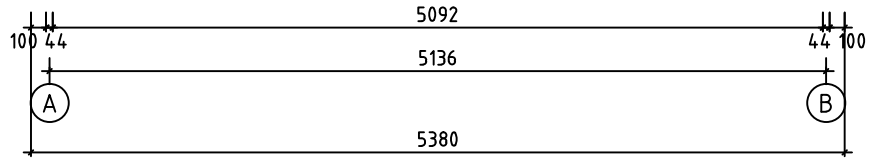

House	Storehouse 44C	Sheet	8
Drawing	WALL-WAND-MUUR 2	Scale	1:50
Material	44x135	Date	06.04.2017
Drawer	RP	File	Storehouse 44C.dwg